

# Data Sheet

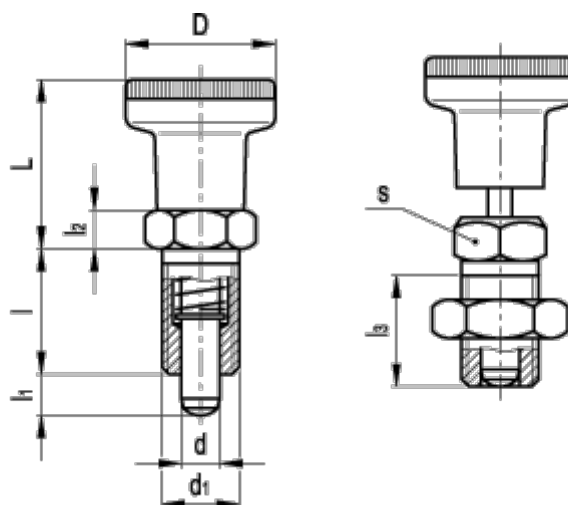

Article number: 2308051502  
Description: E+G Index plunger  
PMT.100-6-M12x1.5-A

## Measures



Code = PMT.100-6-M12x1,5-A	l3	= 17
D = 25	Max. axial load (N)	= 24
d = 6	s	= 14
d1 = M12x1.5		
l = 20		
L = 28		
l1 = 6		
l2 = 6		